

SINGLE N-CHANNEL HIGH SIDE INTELLIGENT POWER DEVICE

DESCRIPTION

The μ PD166005 is N-channel high side driver with charge pump, diagnostic function, embedded protection functions.

When the device is over temperature or over current is generated in output MOS, the protection function operates while the built-in diagnosis output signal is output. In addition, the built-in diagnosis signal is output when open status of the output pin is detected.

FEATURES

- High temperature operation ($T_{ch} = 175^{\circ}\text{C MAX.}$)
- Built-in charge pump circuit
- Low on-state resistance
 $R_{DS(on)} = 100 \text{ m}\Omega \text{ MAX.}$ ($V_{IN} = V_{IH}$, $I_O = 1.5 \text{ A}$, $T_{ch} = 25^{\circ}\text{C}$)
- Built-in protection circuit
 - Current limitation
 - Over temperature protection
- Built-in open load detection circuit
- Built-in diagnosis output circuit
- Package: Power SOP 8

ORDERING INFORMATION

Part Number	Lead plating	Packing	Package
μ PD166005GR-E1-AZ ^{Note}	Sn-Bi	Tape 2500 p/reel	Power SOP 8
μ PD166005GR-E2-AZ ^{Note}	Sn-Bi	Tape 2500 p/reel	Power SOP 8

Note Pb-free (This product does not contain Pb in the external electrode.)

QUALITY GRADE

Part Number	Quality Grade
μ PD166005GR-E1-AZ ^{Note}	Special
μ PD166005GR-E2-AZ ^{Note}	Special

Please refer to "Quality Grades on NEC Semiconductor Devices" (Document No. C11531E) published by NEC Corporation to know the specification of quality grade on the devices and its recommended applications.

APPLICATION

- Switching of types of 14 V loads such as L load, resistance and capacity.

The information in this document is subject to change without notice. Before using this document, please confirm that this is the latest version.
 Not all products and/or types are available in every country. Please check with an NEC Electronics sales representative for availability and additional information.

BLOCK DIAGRAM

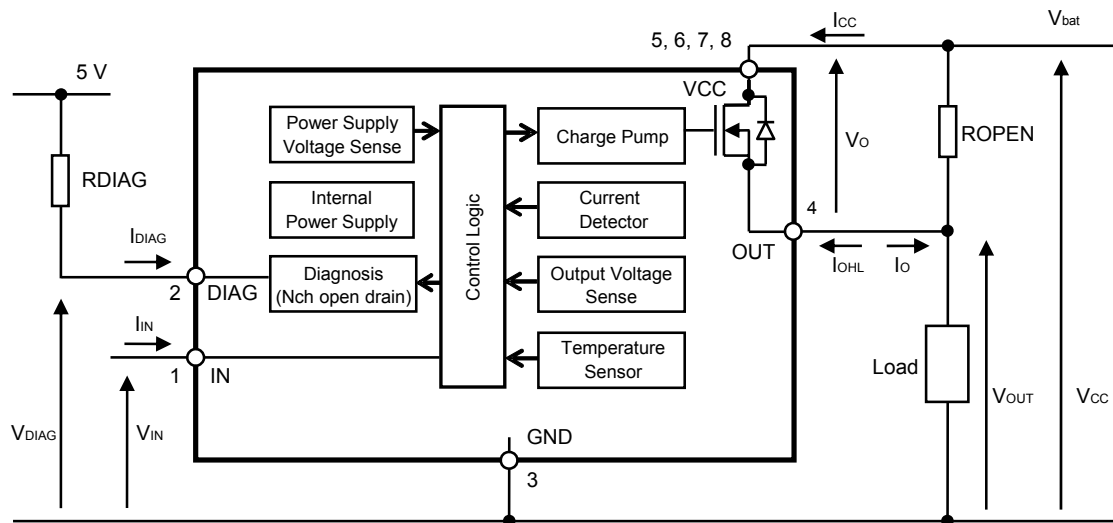

PIN CONFIGURATION

- Power SOP 8

Top View

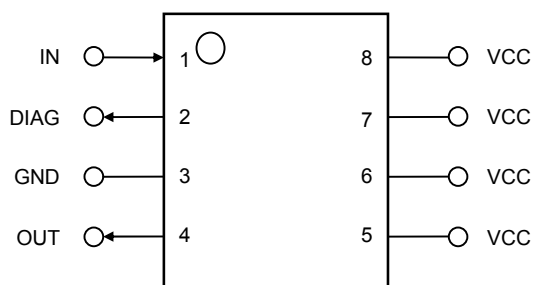

PIN FUNCTIONS

Pin No.	Pin Name	Function
1	IN	Input pin
2	DIAG	DIAG output pin
3	GND	Ground pin
4	OUT	High side output pin
5	VCC	Power supply pin
6	VCC	Power supply pin
7	VCC	Power supply pin
8	VCC	Power supply pin

ABSOLUTE MAXIMUM RATINGS (T_A = 25°C, unless otherwise specified)

Parameter	Symbol	Condition	Rating	Unit
Power supply voltage	V _{CC1}		-0.3 to +35	V
	V _{CC2}	R _s = 1 Ω, τ = 250 ms	60	V
Input voltage	V _{IN}		-0.5 to +7.0	V
Input current	I _{IN}		±10	mA
Output current	I _{OA}		2	A
Output negative voltage	V _{OA}		V _{CC} - 60	V
Power dissipation	P _D	T _A = 25°C ^{Note}	1.0	W
Operation temperature	T _{opt}		-40 to +125	°C
Storage temperature	T _{stg}		-55 to +175	°C
DIAG output voltage	V _{DIAG}		7.0	V
DIAG output current	I _{DIAG}		10	mA

Note When mounted on a glass substrate epoxy (where FR-4 is 10 cm x 10 cm, dimension of copper foil is 15% and thickness of copper foil is 35 μm)

Caution Product quality may suffer if the absolute maximum rating is exceeded even momentarily for any parameters. That is, the absolute maximum ratings are rated values at which the product is on the verge of suffering physical damage, and therefore the product must be used under conditions that ensure that the absolute maximum ratings are not exceeded.

The ratings and conditions indicated for DC characteristics and AC characteristics represent the quality assurance range during normal operation.

RECOMMENDED OPERATING CONDITIONS (T_A = -40°C to +125°C, unless otherwise specified)

Parameter	Symbol	Conditions	MIN.	TYP.	MAX.	Unit
Power supply voltage	V _{CC}	V _{IH} = 3 V, V _O = V _{CC} - 0.4 V (R _L = 9.3 Ω), V _{IL} = 1 V, V _O = 0.2 V (R _L = 9.3 Ω), V _{DIAG} = 0.5 V (I _{DIAG} = 0.6 mA)	4.5		16	V
Input voltage	V _{IH}	V _{CC} = 4.5 to 16 V	3		7.0	V
	V _{IL}		0		1.0	V
Output current	I _{OA}	V _{CC} = 8 to 16 V	0		1.5	A
DIAG output voltage	V _{DIAG}		0		7.0	V
DIAG output current	I _{DIAG}		0		0.6	mA

ELECTRICAL SPECIFICATIONS (V_{CC} = 8 to 16 V, T_{ch} = -40 to +175°C, unless otherwise specified)

Parameter	Symbol	Conditions	MIN.	TYP.	MAX.	Unit
Input voltage	V _{IH}	V _{CC} = 4.5 to 16 V	3		7.0	V
	V _{IL}		0		1.0	V
Input current	I _{IH}	V _{IN} = 5.5 V	30		400	μA
	I _{IL}	V _{IN} = 0 V	-10			μA
Standby current ^{Note1}	I _{CCH}	V _{IN} = V _{IH}			4	mA
	I _{CCL}	V _{IN} = V _{IL}			0.2	mA
Output leakage current	I _{OH1}	V _{IN} = V _{IL} , V _O = V _{CC}			2000	μA
	I _{OH2}	V _{IN} = V _{IL} , V _O = 4 V			400	μA
	I _{OL}	V _{IN} = V _{IL} , V _O = 0 V	-240			μA
DIAG output low level voltage	V _{DIAG}	V _{CC} = 4.5 to 16 V, I _{DIAG} = 0.6 mA			0.5	V
DIAG output leakage current	I _{DIAG}	V _{DIAG} = 7.0 V			10	μA
Open load detection	V _{OIH}	V _{IN} = 0 V, V _{DIAG} changing point (L→H)	4			V
Load connection detection	V _{OIL}	V _{IN} = 0 V, V _{DIAG} changing point (H→L)			1.45	V
Drain to source on-state resistance	R _{DS(on)}	V _{IN} = V _{IH} , I _O = 1.5 A	T _{ch} = 25°C	80	100	mΩ
			T _{ch} = 150°C	150	180	mΩ
Over current detection ^{Note2}	I _s		2		(10)	A
Over temperature detection ^{Note2}	T _{th}		(175)			°C
Turn on delay time	t _{D(ON)}	R _L = 9.3 Ω, V _{CC} = 14 V		5	50	μs
Turn off delay time	t _{D(OFF)}			50	200	μs
Rise time	t _{ON}			30	200	μs
Fall time	t _{OFF}			20	200	μs
DIAG output delay time	t _{Dpd}	R _L = 13 Ω, V _{CC} = 14 V			200	μs
Negative output voltage	-V _O	I _O = -60 mA			V _{CC} - 50	V
Output oscillation cycle at over current condition	t _s	Over current			14	ms
Output on duty at over current condition	D _s				30	%

Notes 1. OUT current and DIAG current are not included.

2. () is a reference value.

MEASUREMENT CONDITION

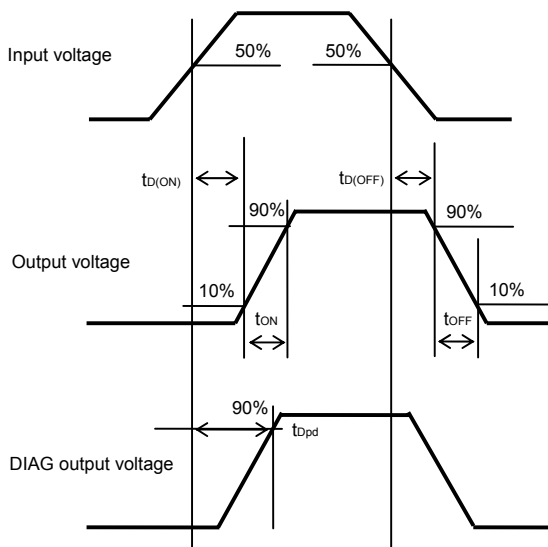

TRUTH TABLE

Parameter	V _{IN}	V _{OUT}	V _{DIAG}
Normal operation	H	H	H
	L	L	L
Over temperature detection	H	L	L
	L	L	L
Over current detection	H	Chopping	L
	L	L	L
Open load detection	H	H	H
	L	H	H

OUTLINE OF FUNCTIONS

Pre-Driver (Charge Pump Circuit) ON/OFF Control

When the input voltage of the input pin (IN) is high level (3.0 V or more), the output MOS (Nch) turns on.
 When the output voltage of the input pin (IN) is low level (1.0 V or less), the output MOS (Nch) turns off.
 Charge pump circuit is built-in to drive the output MOS (Nch) that is connected to the high side.

Over Current Detection Circuit

This circuit detects over current to output pin (OUT) caused by short circuit etc., and feeds back detection signal to control circuit.

When the over current is detected, the current limitation circuit and the control circuit start operation. The output current is restricted and chopping operation begins. The DIAG output is low level at this time.

Over temperature Detection Circuit

This circuit detects over temperature by output MOS (Nch) driving, and feeds back detection signal to control circuit.

When the circuit detects over temperature, the protection function of the control circuit operates and output is shutdown. Output MOS (Nch) automatically restarts when channel temperature cools down after shutdown.

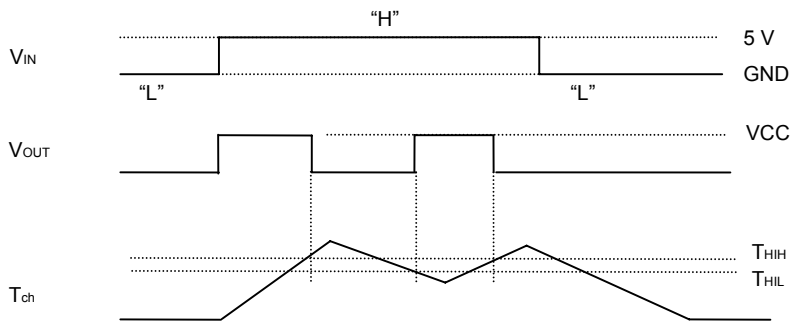

Open Load Detection Circuit

This circuit detects connection/open load of output pin (OUT) when OFF ($V_{IN} = V_{IL}$).

When using the open load detection function, pull-up the output pin (OUT) to VCC. (Recommended value: $5.1\text{ k}\Omega \pm 10\%$)

Open load is detected by inputting low level input voltage (1.0 V or less) to input pin (IN). DIAG pin outputs Hi-Z (pull-up: high level) when the output pin is open.

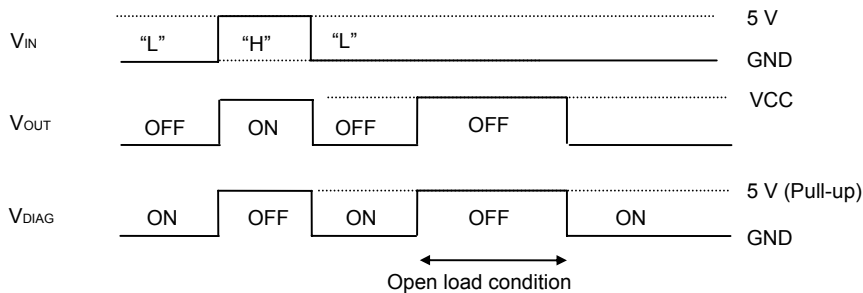

Remark The pull-up resistance does not affect other circuits and electronic characteristics.

Diagnostic Output Circuit

This circuit controls output of diagnosis signal form DIAG pin when Over current or Over temperature or Open load is detected.

TIMING CHART

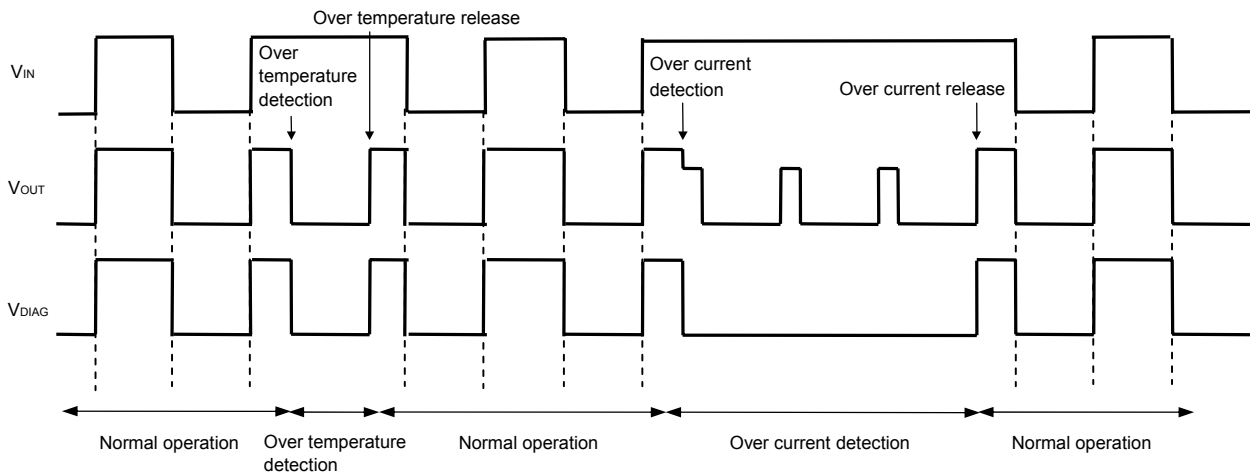

EXAMPLE OF APPLICATION CIRCUIT

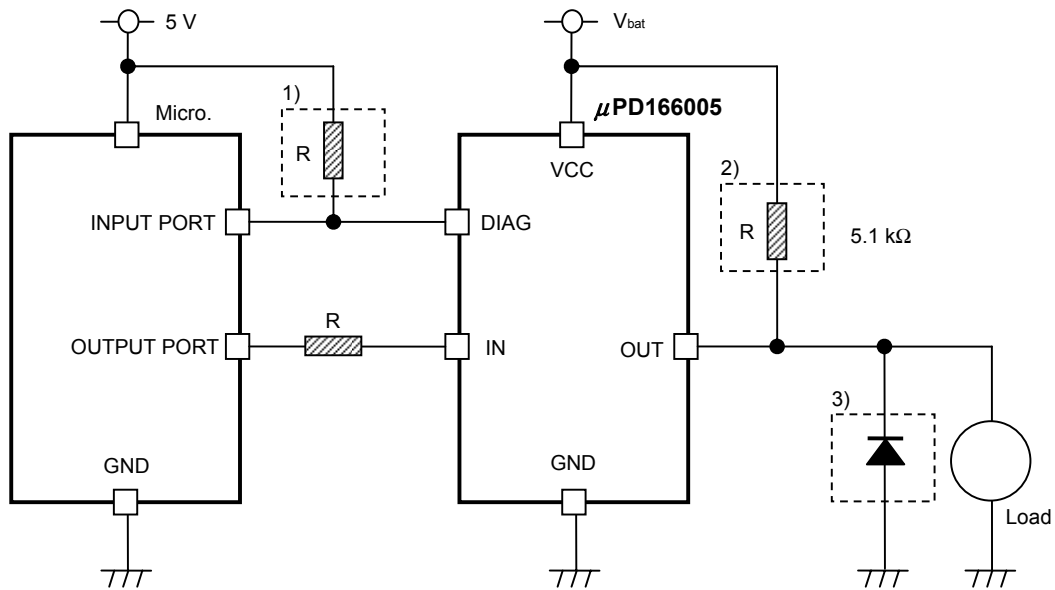

- Cautions**
1. DIAG pin is Nch open drain structure. When using diagnostic function, pull-up DIAG pin to 5 V. (power supply lines such as Microcomputer)
 2. When using Open load detection function, Pull-up OUT pin to Vcc. (Recommended value: 5.1 kΩ±10%) (The pull-up resistance does not affect other circuits and electronic characteristics.)
 3. If output load voltage exceeds Vcc – 50 V when L load is driven, it is necessary to protect this product with an external rectifying diode or zener diode.
 4. This circuit diagram is shown as an example of connection, and is not intended for mass production design.

TYPICAL CHARACTERISTICS

INPUT VOLTAGE vs. POWER SUPPLY VOLTAGE

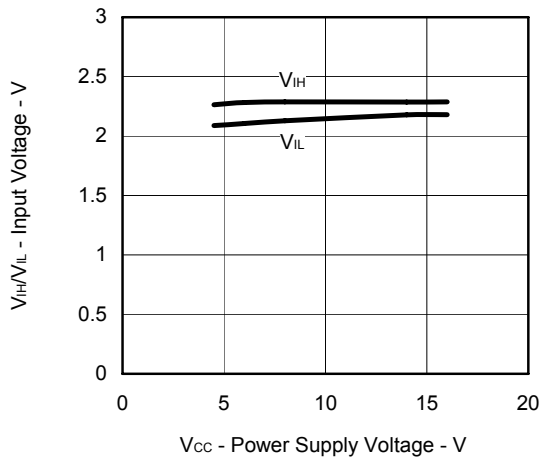

INPUT VOLTAGE vs. AMBIENT TEMPERATURE

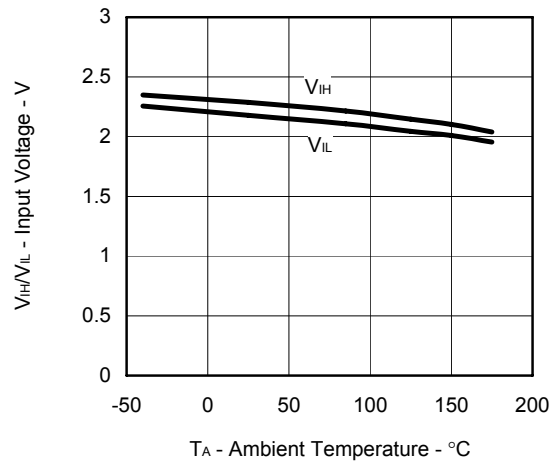

HIGH LEVEL INPUT CURRENT vs. AMBIENT TEMPERATURE

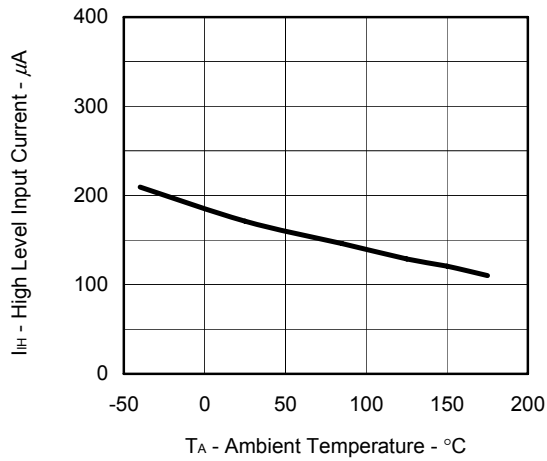

LOW LEVEL INPUT CURRENT vs. AMBIENT TEMPERATURE

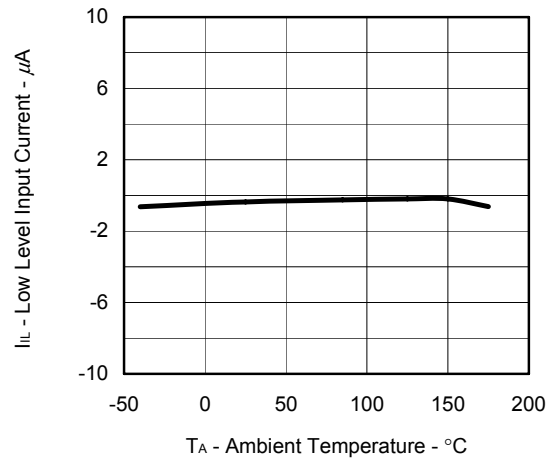

STUNDBY CURRENT vs. AMBIENT TEMPERATURE

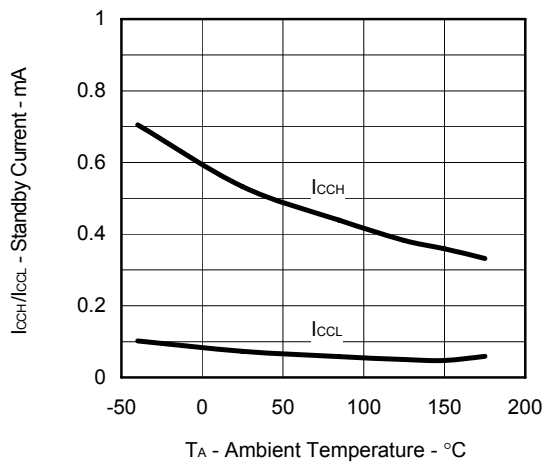

OUTPUT LEAKAGE CURRENT vs. AMBIENT TEMPERATURE

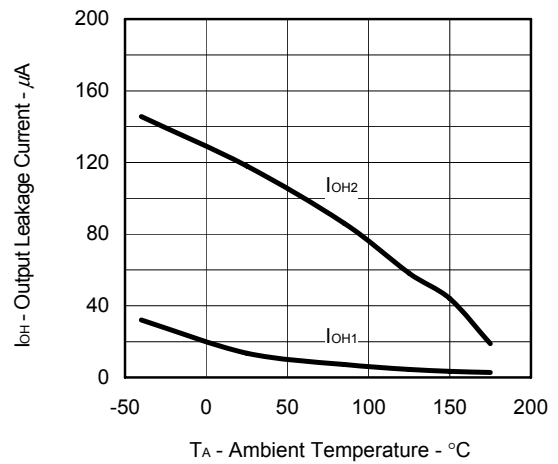

OUTPUT LEAKAGE CURRENT vs. AMBIENT TEMPERATURE

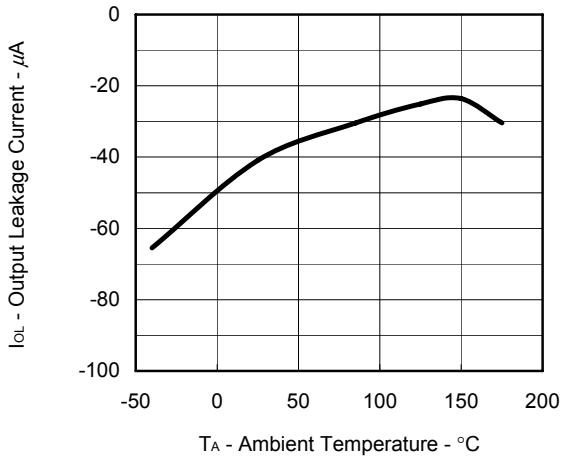

DIAG OUTPUT LOW LEVEL VOLTAGE vs. POWER SUPPLY VOLTAGE

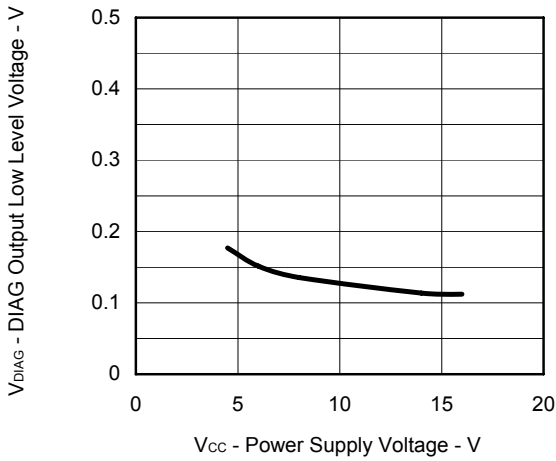

DIAG OUTPUT LOW LEVEL VOLTAGE vs. AMBIENT TEMPERATURE

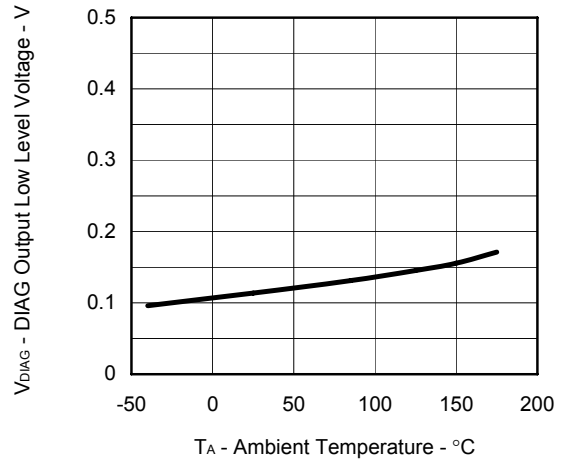

OPEN LOAD/LOAD CONNECTION DETECTION VOLTAGE vs. POWER SUPPLY VOLTAGE

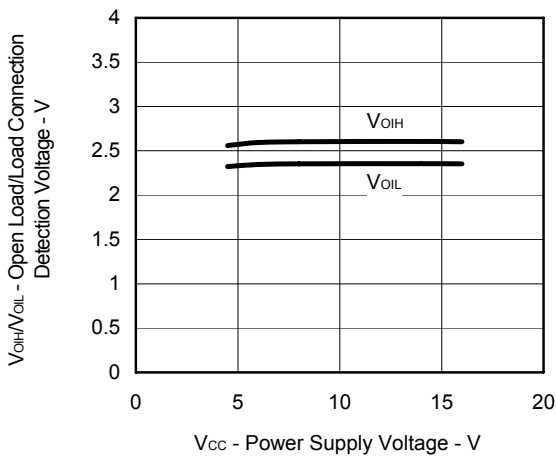

OPEN LOAD / LOAD CONNECTION DETECTION VOLTAGE vs. AMBIENT TEMPERATURE

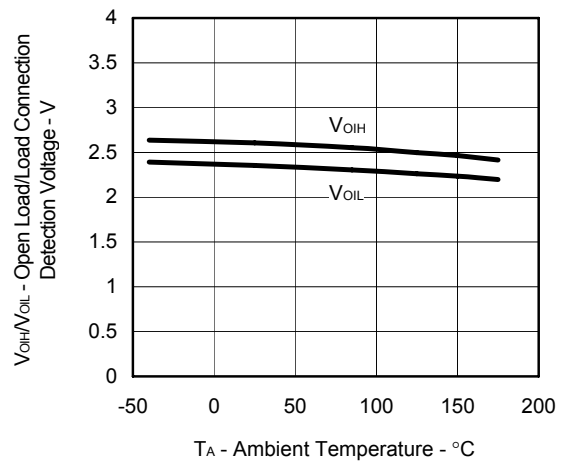

DRAIN TO SOURCE ON-STATE RESISTANCE vs. POWER SUPPLY VOLTAGE

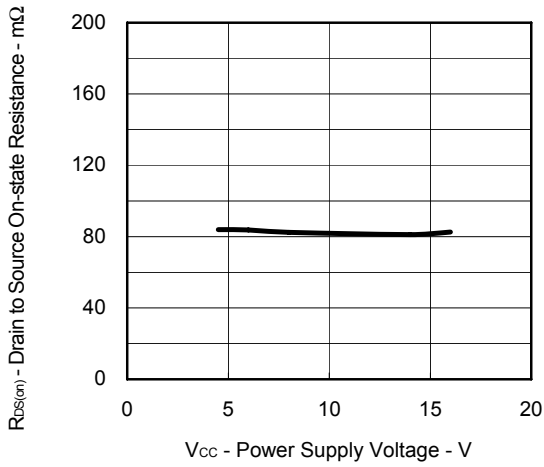

DRAIN TO SOURCE ON-STATE RESISTANCE vs. AMBIENT TEMPERATURE

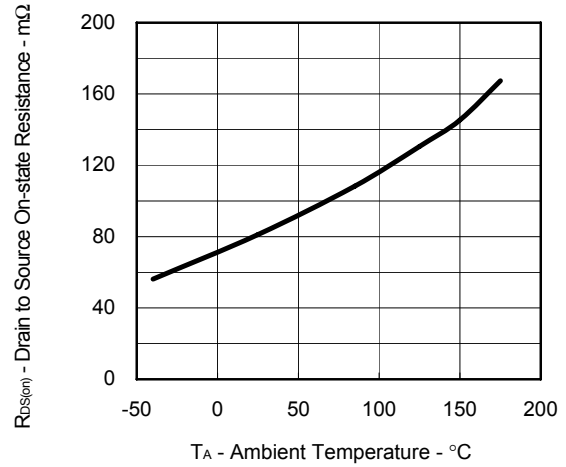

OVER CURRENT DETECTION vs. POWER SUPPLY VOLTAGE

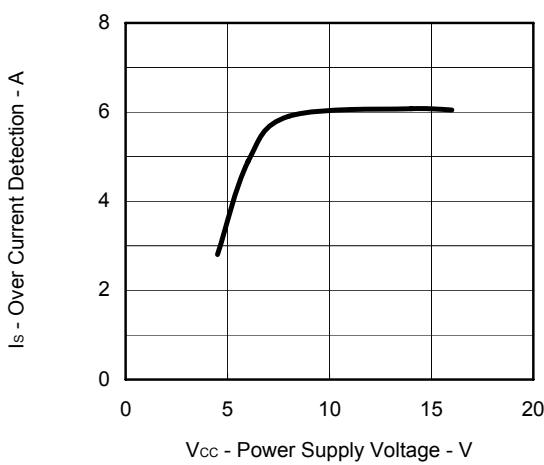

OVER CURRENT DETECTION vs. AMBIENT TEMPERATURE

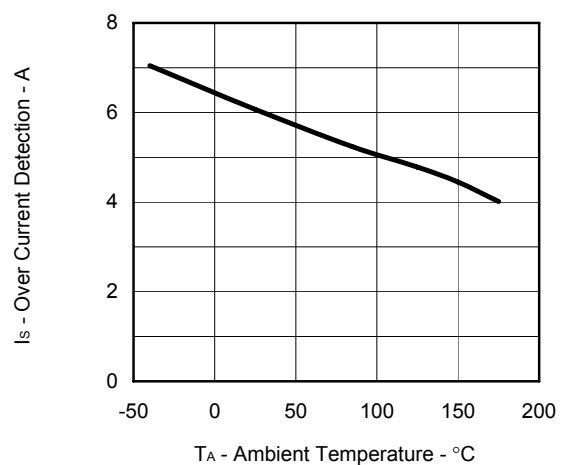

OUTPUT OSCILLATION CYCLE AT OVER CURRENT CONDITION vs. POWER SUPPLY VOLTAGE

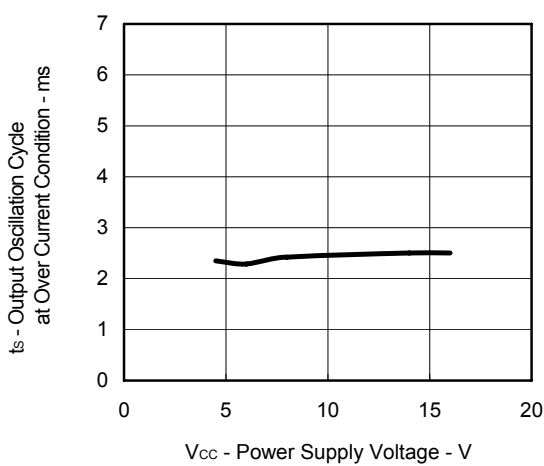

OUTPUT OSCILLATION CYCLE AT OVER CURRENT CONDITION vs. AMBIENT TEMPERATURE

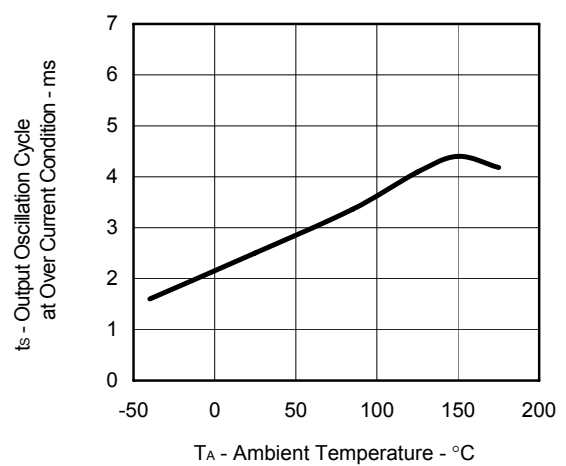

OUTPUT ON DUTY AT OVER CURRENT CONDITION vs. POWER SUPPLY VOLTAGE

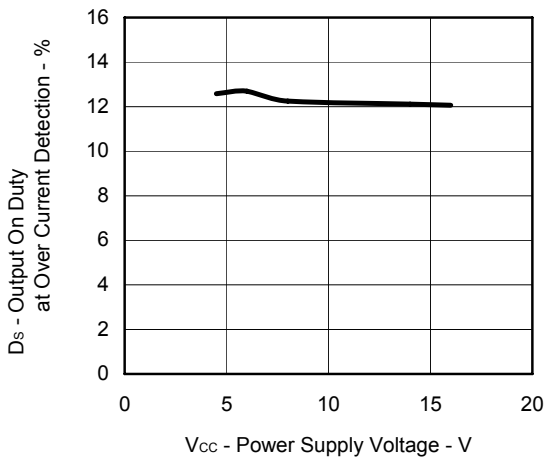

OUTPUT ON DUTY AT OVER CURRENT CONDITION vs. AMBIENT TEMPERATURE

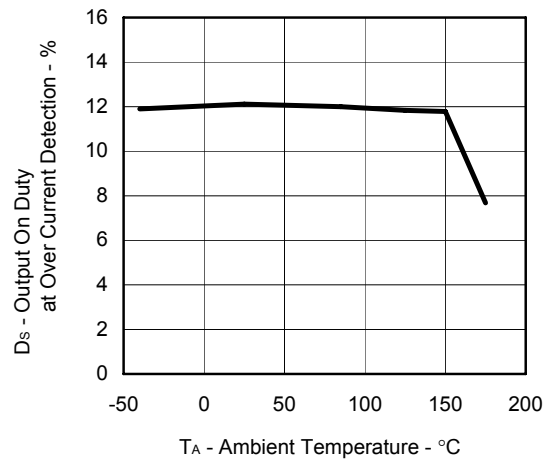

TURN ON DELAY TIME vs. AMBIENT TEMPERATURE

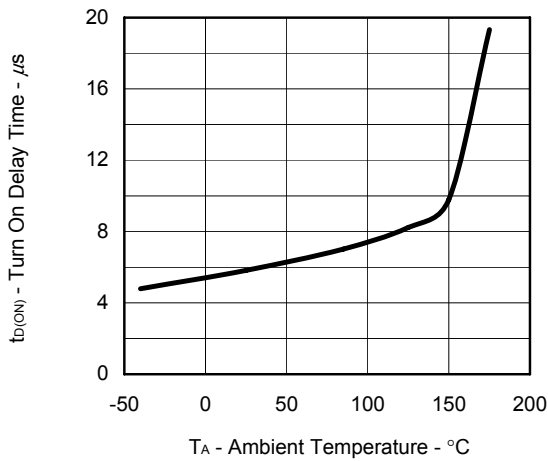

TURN OFF DELAY TIME vs. AMBIENT TEMPERATURE

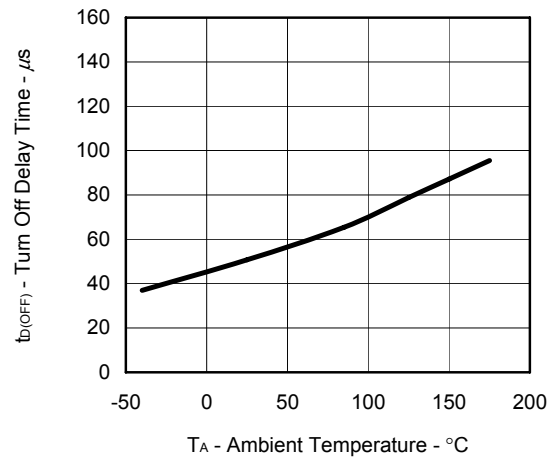

RISE TIME vs. AMBIENT TEMPERATURE

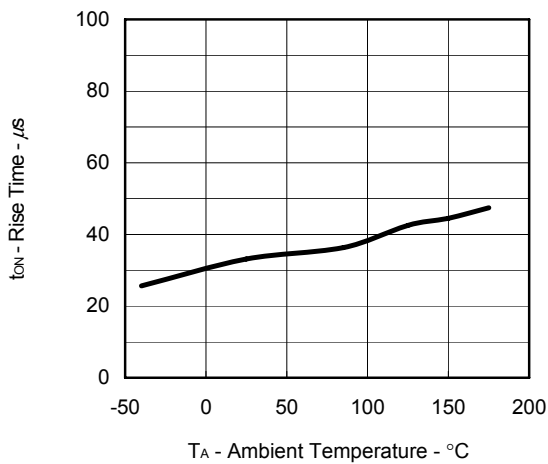

FALL TIME vs. AMBIENT TEMPERATURE

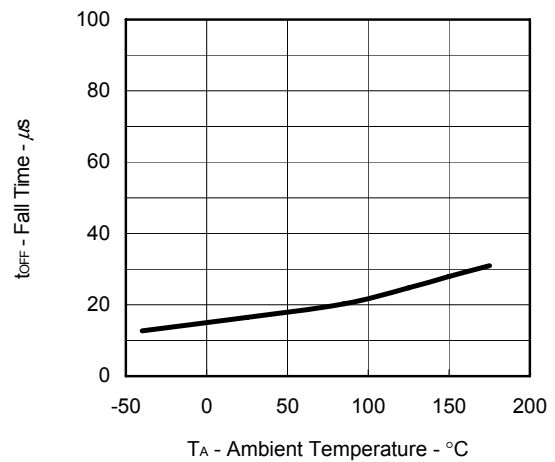

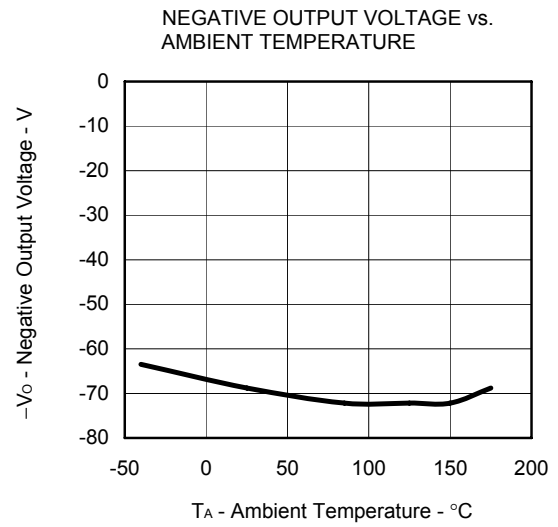
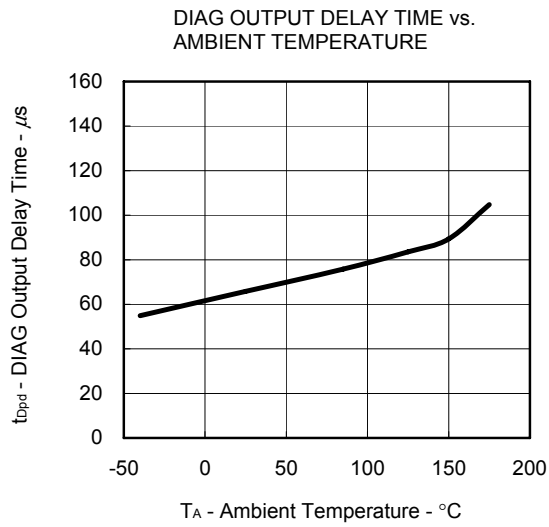

TRANSIENT THERMAL RESISTANCE CHARACTERISTICS

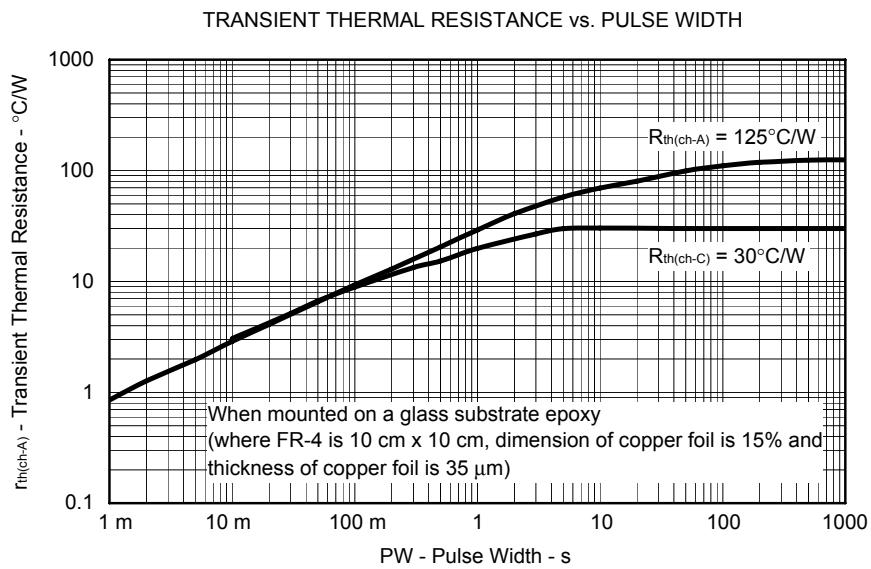

PACKAGE DRAWING

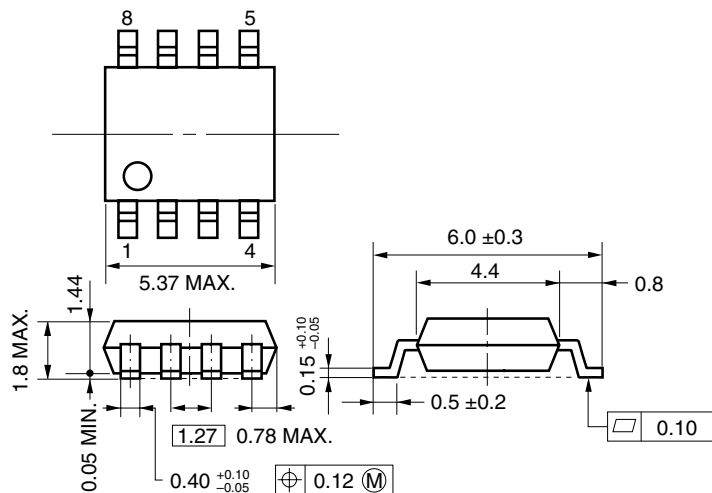

TAPE INFORMATION

There are two types (-E1, -E2) of taping depending on the direction of the device.

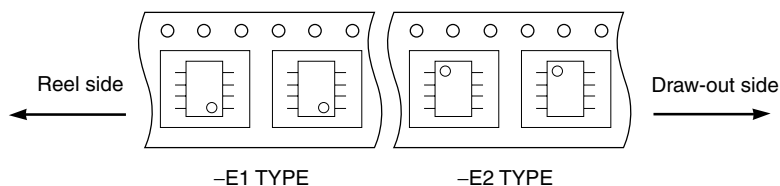

MARKING INFORMATION

This figure indicates the marking items and arrangement. However, details of the letterform, the size and the position aren't indicated.

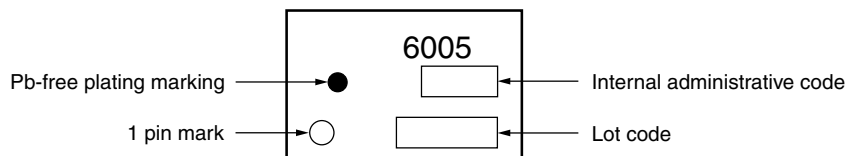

RECOMMENDED SOLDERING CONDITIONS

The μPD166005 should be soldered and mounted under the following recommended conditions.

For soldering methods and conditions other than those recommended below, contact an NEC Electronics sales representative.

For technical information, see the following website.

Semiconductor Device Mount Manual (<http://www.necel.com/pkg/en/mount/index.html>)

- μPD166005GR-E1-AZ **Note**: Power SOP 8
- μPD166005GR-E2-AZ **Note**: Power SOP 8

Process	Conditions	Symbol
Infrared reflow	Maximum temperature (package's surface temperature): 260°C or below, Time at maximum temperature: 10 seconds or less, Time at temperature higher than 220°C: 60 seconds or less, Preheating time at 160°C to 180°C: 60 to 120 seconds, Times: Three times, Flux: Rosin flux with low chlorine (0.2 Wt% or below) recommended.	IR60-00-3
Partial Heating Method	Pin temperature: 300°C or below, Heat time: 3 seconds or less (Per each side of the device), Flux: Rosin flux with low chlorine (0.2 Wt% or below) recommended.	-

Note Pb-free (This product does not contain Pb in the external electrode.)

NOTES FOR CMOS DEVICES

① VOLTAGE APPLICATION WAVEFORM AT INPUT PIN

Waveform distortion due to input noise or a reflected wave may cause malfunction. If the input of the CMOS device stays in the area between V_{IL} (MAX) and V_{IH} (MIN) due to noise, etc., the device may malfunction. Take care to prevent chattering noise from entering the device when the input level is fixed, and also in the transition period when the input level passes through the area between V_{IL} (MAX) and V_{IH} (MIN).

② HANDLING OF UNUSED INPUT PINS

Unconnected CMOS device inputs can be cause of malfunction. If an input pin is unconnected, it is possible that an internal input level may be generated due to noise, etc., causing malfunction. CMOS devices behave differently than Bipolar or NMOS devices. Input levels of CMOS devices must be fixed high or low by using pull-up or pull-down circuitry. Each unused pin should be connected to V_{DD} or GND via a resistor if there is a possibility that it will be an output pin. All handling related to unused pins must be judged separately for each device and according to related specifications governing the device.

③ PRECAUTION AGAINST ESD

A strong electric field, when exposed to a MOS device, can cause destruction of the gate oxide and ultimately degrade the device operation. Steps must be taken to stop generation of static electricity as much as possible, and quickly dissipate it when it has occurred. Environmental control must be adequate. When it is dry, a humidifier should be used. It is recommended to avoid using insulators that easily build up static electricity. Semiconductor devices must be stored and transported in an anti-static container, static shielding bag or conductive material. All test and measurement tools including work benches and floors should be grounded. The operator should be grounded using a wrist strap. Semiconductor devices must not be touched with bare hands. Similar precautions need to be taken for PW boards with mounted semiconductor devices.

④ STATUS BEFORE INITIALIZATION

Power-on does not necessarily define the initial status of a MOS device. Immediately after the power source is turned ON, devices with reset functions have not yet been initialized. Hence, power-on does not guarantee output pin levels, I/O settings or contents of registers. A device is not initialized until the reset signal is received. A reset operation must be executed immediately after power-on for devices with reset functions.

⑤ POWER ON/OFF SEQUENCE

In the case of a device that uses different power supplies for the internal operation and external interface, as a rule, switch on the external power supply after switching on the internal power supply. When switching the power supply off, as a rule, switch off the external power supply and then the internal power supply. Use of the reverse power on/off sequences may result in the application of an overvoltage to the internal elements of the device, causing malfunction and degradation of internal elements due to the passage of an abnormal current.

The correct power on/off sequence must be judged separately for each device and according to related specifications governing the device.

⑥ INPUT OF SIGNAL DURING POWER OFF STATE

Do not input signals or an I/O pull-up power supply while the device is not powered. The current injection that results from input of such a signal or I/O pull-up power supply may cause malfunction and the abnormal current that passes in the device at this time may cause degradation of internal elements. Input of signals during the power off state must be judged separately for each device and according to related specifications governing the device.

• **The information in this document is current as of July, 2008. The information is subject to change without notice. For actual design-in, refer to the latest publications of NEC Electronics data sheets or data books, etc., for the most up-to-date specifications of NEC Electronics products. Not all products and/or types are available in every country. Please check with an NEC Electronics sales representative for availability and additional information.**

- No part of this document may be copied or reproduced in any form or by any means without the prior written consent of NEC Electronics. NEC Electronics assumes no responsibility for any errors that may appear in this document.
- NEC Electronics does not assume any liability for infringement of patents, copyrights or other intellectual property rights of third parties by or arising from the use of NEC Electronics products listed in this document or any other liability arising from the use of such products. No license, express, implied or otherwise, is granted under any patents, copyrights or other intellectual property rights of NEC Electronics or others.
- Descriptions of circuits, software and other related information in this document are provided for illustrative purposes in semiconductor product operation and application examples. The incorporation of these circuits, software and information in the design of a customer's equipment shall be done under the full responsibility of the customer. NEC Electronics assumes no responsibility for any losses incurred by customers or third parties arising from the use of these circuits, software and information.
- While NEC Electronics endeavors to enhance the quality, reliability and safety of NEC Electronics products, customers agree and acknowledge that the possibility of defects thereof cannot be eliminated entirely. To minimize risks of damage to property or injury (including death) to persons arising from defects in NEC Electronics products, customers must incorporate sufficient safety measures in their design, such as redundancy, fire-containment and anti-failure features.
- NEC Electronics products are classified into the following three quality grades: "Standard", "Special" and "Specific".

The "Specific" quality grade applies only to NEC Electronics products developed based on a customer-designated "quality assurance program" for a specific application. The recommended applications of an NEC Electronics product depend on its quality grade, as indicated below. Customers must check the quality grade of each NEC Electronics product before using it in a particular application.

"Standard": Computers, office equipment, communications equipment, test and measurement equipment, audio and visual equipment, home electronic appliances, machine tools, personal electronic equipment and industrial robots.

"Special": Transportation equipment (automobiles, trains, ships, etc.), traffic control systems, anti-disaster systems, anti-crime systems, safety equipment and medical equipment (not specifically designed for life support).

"Specific": Aircraft, aerospace equipment, submersible repeaters, nuclear reactor control systems, life support systems and medical equipment for life support, etc.

The quality grade of NEC Electronics products is "Standard" unless otherwise expressly specified in NEC Electronics data sheets or data books, etc. If customers wish to use NEC Electronics products in applications not intended by NEC Electronics, they must contact an NEC Electronics sales representative in advance to determine NEC Electronics' willingness to support a given application.

(Note)

(1) "NEC Electronics" as used in this statement means NEC Electronics Corporation and also includes its majority-owned subsidiaries.

(2) "NEC Electronics products" means any product developed or manufactured by or for NEC Electronics (as defined above).